



FOURNISSEUR DE MENUISERIES BOIS ET BOIS-ALUMINIUM

SUPPLIER OF WOOD AND WOOD-ALUMINUM WINDOWS



SOMMAIRE / INDEX

Notre Histoire <i>Our Story</i>	03
Projets <i>Projects</i>	05
Profils <i>Profiles</i>	20
Bois <i>Wood</i>	21
Profil Standard <i>Standard Profile</i>	22
Profil Traditionnel <i>Traditional Profile</i>	23
Mouton et Gueule de Loup <i>Mouton et Gueule de Loup Profile</i>	24
Bois-Aluminium <i>Wood-Aluminium</i>	25
Produits <i>Products</i>	26
Informations Techniques <i>Technical Information</i>	35

NOTRE HISTOIRE

Avec plus de 20 ans d'expérience, Mestre Raposa est un spécialiste des menuiseries en bois basé dans le sud de l'Europe. Avec plus de 5 000 projets menés à bien avec succès, notre entreprise est devenue l'un des leaders du marché des portes et fenêtres.

Notre expérience dans la région nous a démontré l'importance de la protection contre l'exposition aux UV et le changement climatique; c'est pourquoi nous utilisons les dernières technologies en matière de traitement du bois, pour garantir sa durabilité face aux facteurs externes pouvant le détériorer.

Notre particularité, en tant que fournisseur de menuiseries, réside dans le fait que nous travaillons exclusivement avec des partenaires B2B: architectes, entrepreneurs, grossistes et entreprises d'installation de fenêtres font partie des clients réguliers de Mestre Raposa International®.

OUR STORY

With over 20 years of experience, Mestre Raposa is a wooden window specialist in the Southern Europe. More than 5000 projects were realized successfully making our company on the top of the windows and doors market.

Our experience has taught us the importance of protection against UV exposures and climate changes; therefore, we use the latest technologies in wooden treatments to guarantee its durability.

Our Distinction comes from the fact that we work exclusively with B2B partners: architects, building contractors, wholesalers and window installation companies are among Mestre Raposa International's regular clients.

20

Ans d'expérience
Years of experience

5000

Projets
Projects

30

Salariés
Employees





En plus de notre activité au Portugal, nous sommes également présents en France et en Espagne.
In addition to our activities in Portugal, we are also operating in France and Spain.



Maison traditionnelle avec fenêtres et volets en bois.
Traditional house with wooden windows and interior wooden shutters.



Hostel avec fenêtres traditionnelles en bois.
Hostel with traditional wooden windows.



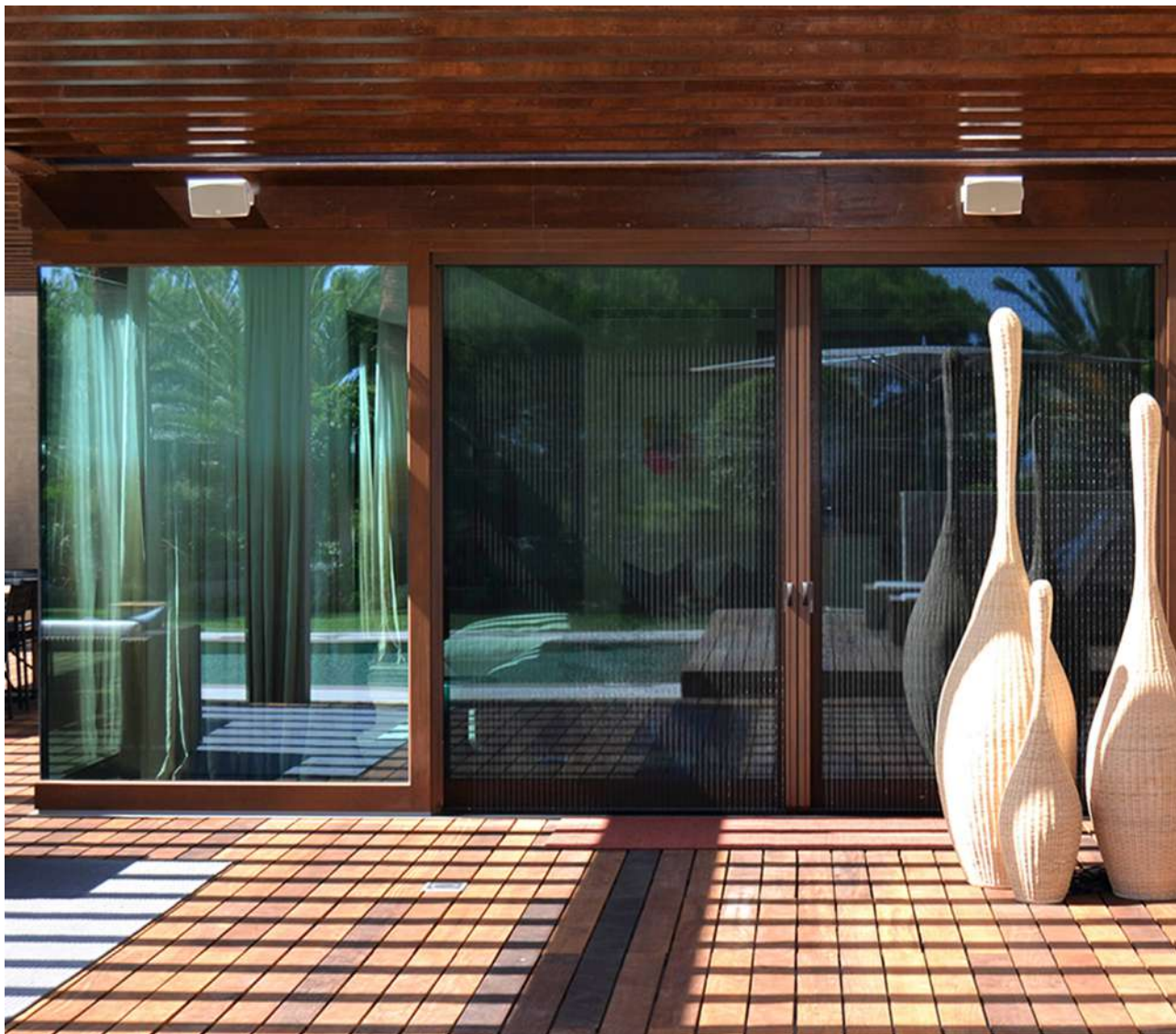

Châlet de 500m² avec fenêtres levante-coulissantes en bois.
Wooden 500m² Villa with wooden sliding windows.



Rénovation complète de la maison, avec conservation du style traditionnel de fenêtres, portes-fenêtres et volets en chêne.
Full house window replacement, keeping the traditional style of oak windows, exterior doors and shutters.



Portes-fenêtres et volets exterieures en Pin Nordique vernis.
Exterior doors, windows and shutters made of varnished Nordic Pine.



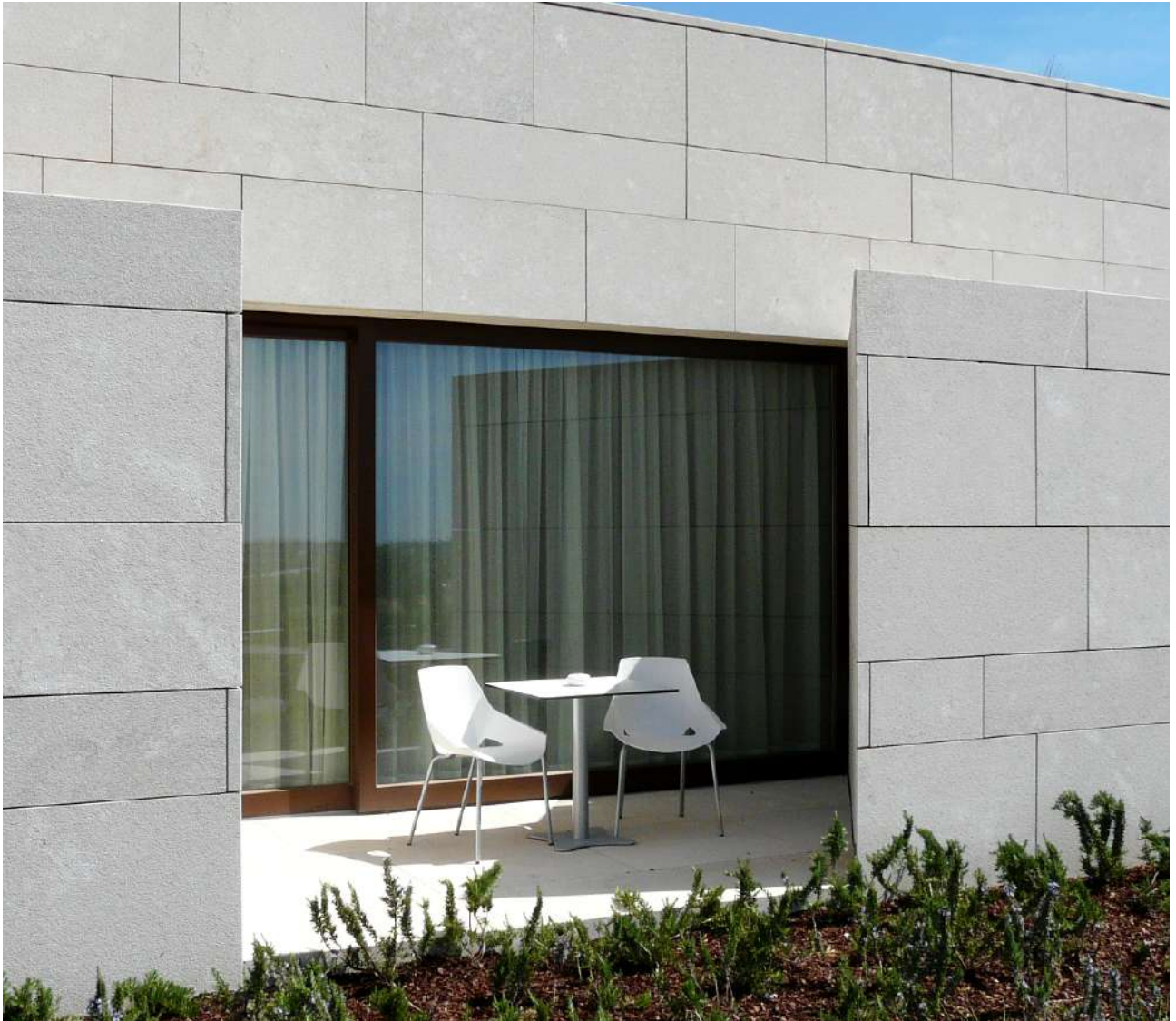

Porte levante-coulissante dans la partie moderne du Palácio de Estoi.
Lift and slide door in the modern part of Palácio de Estoi.



Fenêtres historiques en bois pour rénovation de la partie antique du Palácio de Estoi, et fenêtres levantes-coulissantes pour la partie moderne.

Historic wooden windows for the ancient part of Palácio de Estoi and modern sliding doors for the new part.

Nouvelles fenêtres et portes-fenêtres en bois de couleur anthracite, avec conservation du même style, mais avec une meilleure isolation.
New anthracite wood windows and balcony doors with optimal isolation but keeping the same shape.







Portes et fenêtres en bois Accoya pour maison rurale en Europe du Sud.
Wooden windows and doors in Accoya for rural mansion in Southern Europe.



Hotel rural avec portes et fenêtres en bois de couleur bleu et rouge.
Country hotel with wooden windows and doors in red and blue.



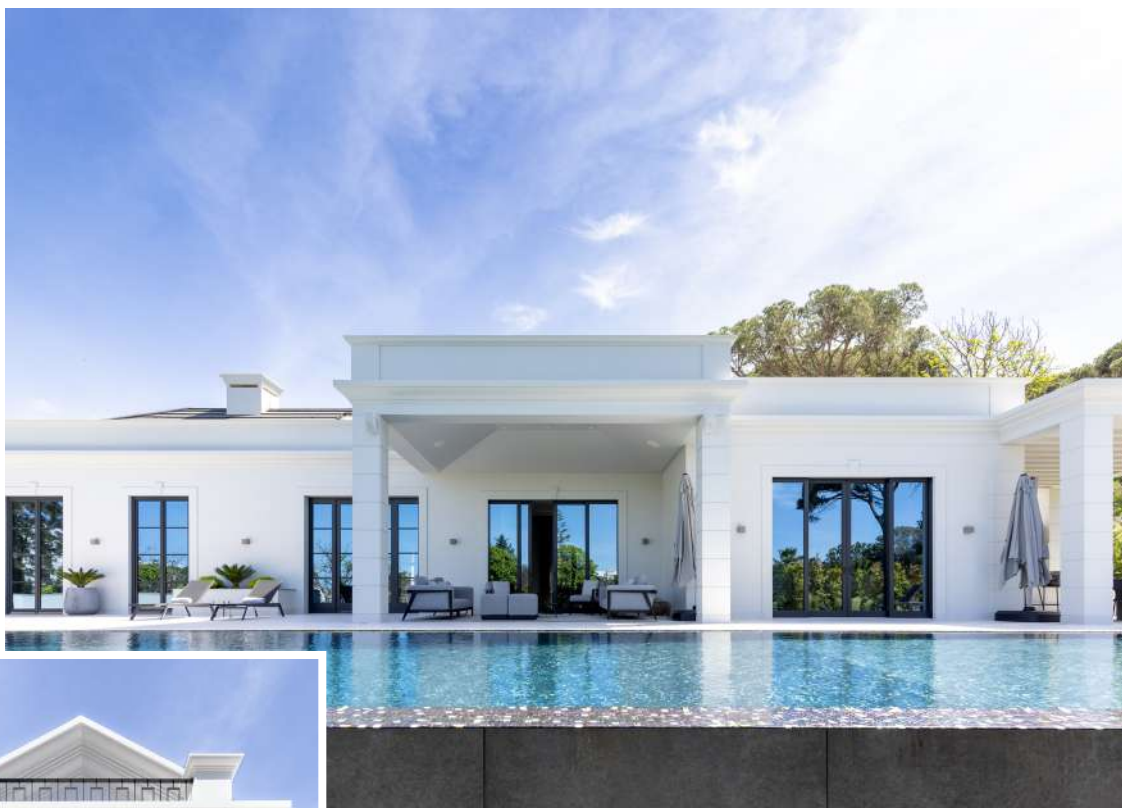

Fenêtres, portes et systèmes coulissants en bois pour une maison d'été en l'Algarve.
Wooden windows, doors and sliding systems for a summer house in the Algarve.



Fenêtres de couleur verte en Pin Nordique.
Green windows in Nordic Pine.



PROFILS *PROFILES*

Bois / Wood



Chêne / Oak
Uf = 1,4 W/(m²K)

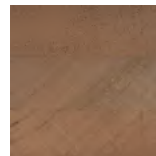

Méranti / Meranti
Uf = 1,4 W/(m²K)



Mélèze / Larch
Uf = 1,3 W/(m²K)



Pin / Pine
Uf = 1,3 W/(m²K)

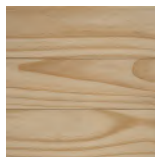

Accoya / Accoya
Uf ≈ 0.7 to 1.1 W/
(m²K)

Pin
Pine

Méranti
Meranti

Chêne
Oak

Accoya
Accoya

Mélèze
Larch



Perméabilité à l'air
Classe 4



Air permeability
Class 4



Étanchéité à l'eau
Classe 9A



Water tightness
Class 9A



Résistance au vent
Classe C3



Wind resistance
Class C3

Profil Standard

Standard Profile

Ref.: MR 68, MR 78, MR 88.

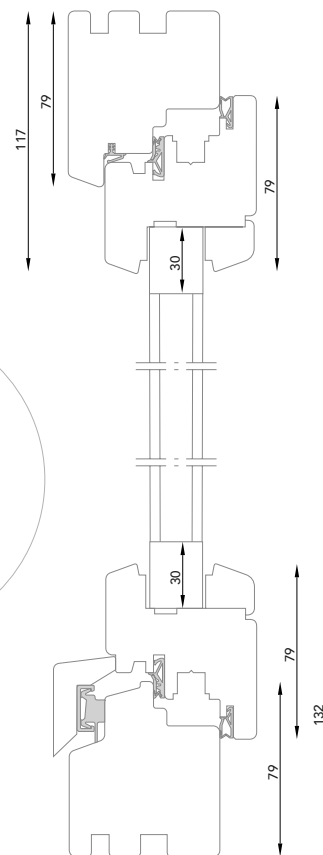

Dessin Technique
Technical Design

Système testé par
System tested by:

FCBA - Bordeaux - France
ITeCons - Coimbra - Portugal

Classe AEV: A*4-E*9A-V*C3
Class AEV: A*4-E*9A-V*C3

Profil Traditionnel

Traditional Profile

Ref.: MR 68, MR 78, MR 88.

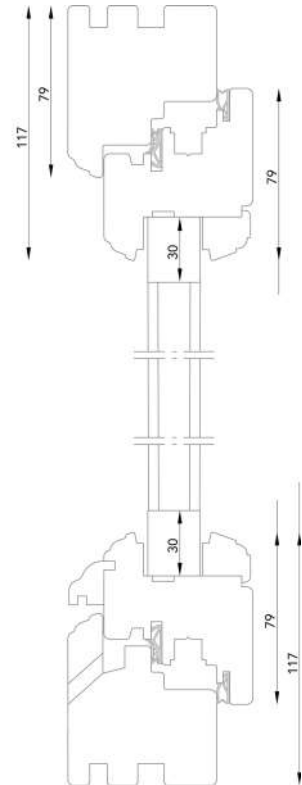
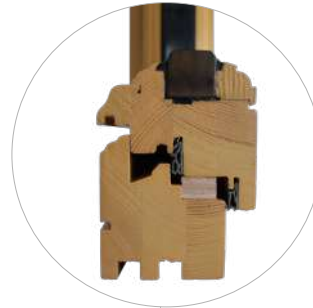

Dessin Technique
Technical Design

Profil Mouton et Gueule de Loup

Mouton et Gueule de Loup Profile

Ref.: MR 56 GDL, MR 68 GDL.

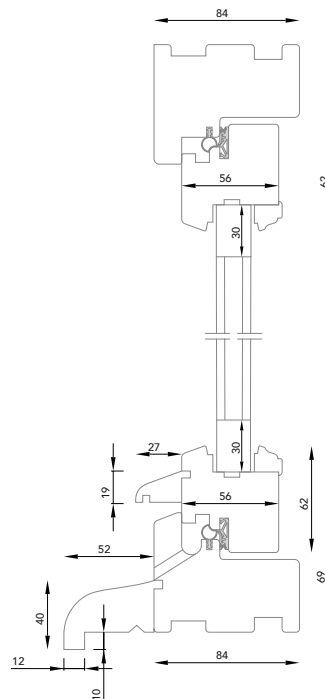

Dessin Technique
Technical Design



BOIS-ALUMINIUM WOOD-ALUMINIUM

Ref.: MR 68, MR 78, MR 88.

Disponible en Pin, Méranti, Chêne et Mélèze.

Available in Pine, Meranti, Oak and Larch.

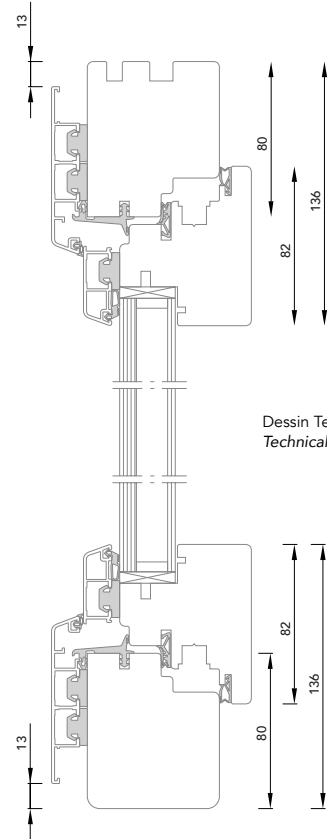
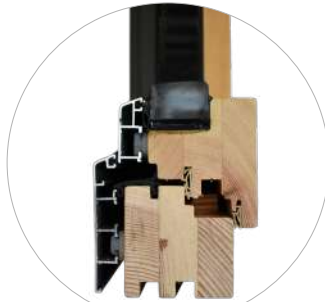

Dessin Technique
Technical Design

Système testé par:
System tested by:

FCBA - Bordeaux - France

Classe AEV: A*4-E*6A-V*C3
Class AEV: A*4-E*6A-V*C3



Perméabilité à l'air
Classe 4



Air permeability
Class 4



Étanchéité à l'eau
Classe 6A



Water tightness
Class 6A



Résistance au vent
Classe C3



Wind resistance
Class C3

PRODUITS *PRODUCTS*

PORTE-FENÊTRE BALCONY DOOR

Ref.: MR 68, MR 78, MR 88.

Disponible en : Pin, MÉRANTI, Chêne, Mélèze (sur demande), Accoya

Available in: Pine, Meranti, Oak, Larch (upon request), Accoya.

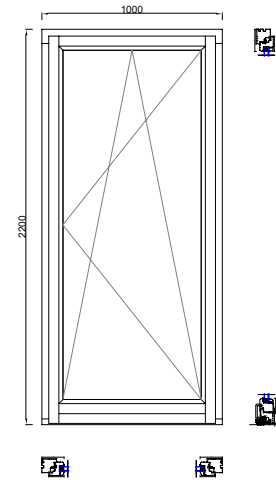

Dessin Technique
Technical Design

Seuil aluminium porte-fenêtre Aluminum window threshold

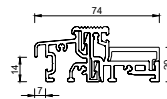

GUTMANN à 32mm
(Standard)

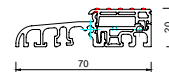

BKV 70T à 20 mm
(PMR minimum)

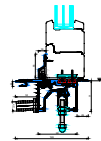

Alumat MFAT10
à 0mm

Porte-fenêtre en bois blanc.
White wooden balcony door.

FENÊTRE CINTRÉE

ARCH WINDOWS

Ref.: MR 68, MR 78, MR 88.

Disponible en : Pin, Méranti, Chêne, Mélèze (sur demande), Accoya
Available in: Pine, Meranti, Oak, Larch (upon request), Accoya.

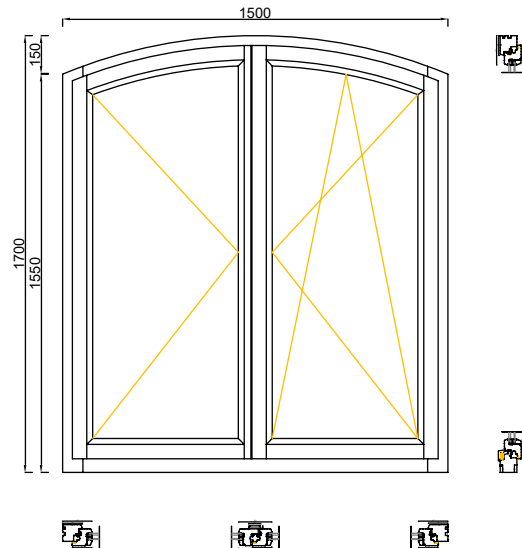

Dessin Technique
Technical Design

Fenêtre cintrée en bois.
Wooden arch window.

FENÊTRE GUILLOTINE

GUILLOTINE WINDOWS

Ref.: MR 68, MR 78, MR 88.

Disponible en : Pin, Méranti, Chêne, Mélèze (sur demande), Accoya
Available in: Pine, Meranti, Oak, Larch (upon request), Accoya.



Fenêtre guillotine en bois.
Wooden guillotine window.

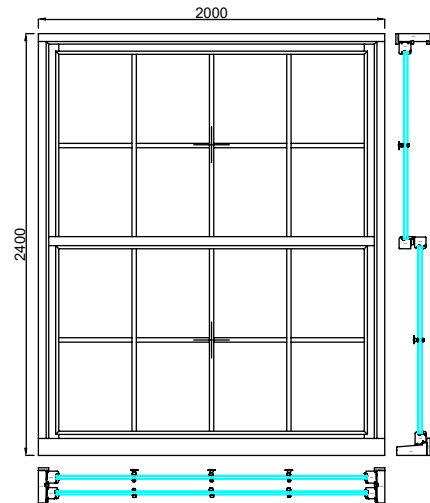

Dessin Technique
Technical Design

PORTES D'ENTRÉE ENTRANCE DOORS



Portes d'entrée en bois sur mesure pour votre projet.
Grâce à leur design exclusif et de haute technologie, les portes d'entrée en bois de Mestre Raposa peuvent avoir différentes tailles et formes.

Wood entrance doors custom-made to your project.
Thanks to their exclusive hi-tech design, Mestre Raposa's front doors can have different sizes and shapes.



Porte d'entrée traditionnelle en bois.
Traditional wooden entrance door.

PORTES D'ENTRÉE ENTRANCE DOORS

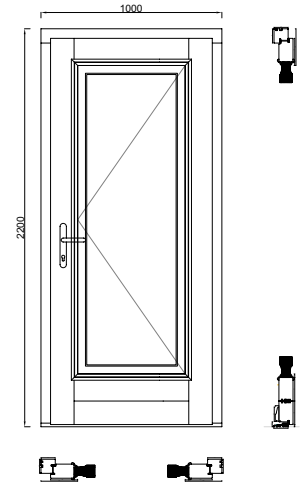

Dessin Technique
Technical Design

Panneaux disponibles / Available panels

Mouluré / Pad

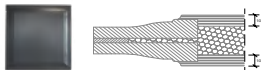

Lisse / Flat

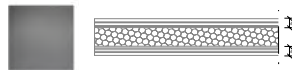
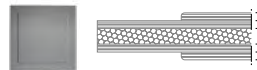
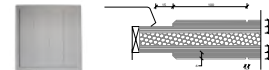

Plate - Bande / Flat Pad



Rainuré - Vertical / Vertical Millings



PORTE LEVANTE-COULISSANTE

LIFT AND SLIDE DOOR

Ref.: MR 68, MR 78, MR 88.

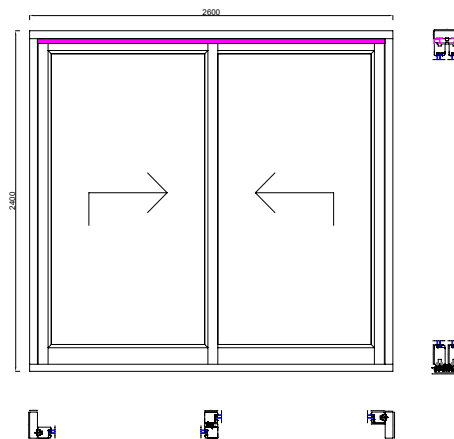

Dessin Technique
Technical Design

Schémas / Schema



A D E G



C L

Porte levante-coulissante en bois blanc avec vue panoramique.
White wooden lift and slide door with panoramic view.

PORTE PLIANTE-COULISSANTE

FOLDING DOOR

Ref.: MR 68, MR 78, MR 88.



Porte pliante-coulissante en bois, disponible en configurations personnalisables.

Wooden folding door, available in customizable configurations

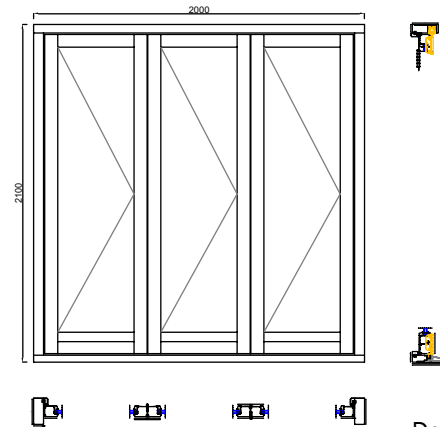

Dessin Technique
Technical Design

Schémas / Schema



321

330

431

532

541



550

633

651



743

761

770



871

VOLETS BATTANS EN BOIS WOODEN SHUTTERS

Extérieur / Exterior



Intérieur / Interior



Quincallerie / Hardware

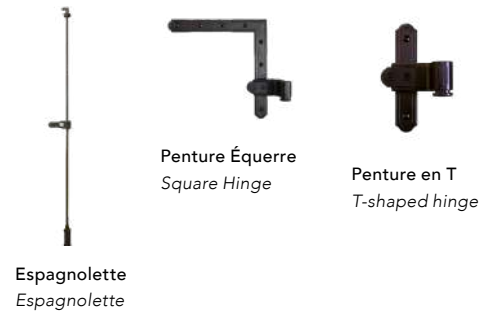

Type de Pose / Type Of Installation

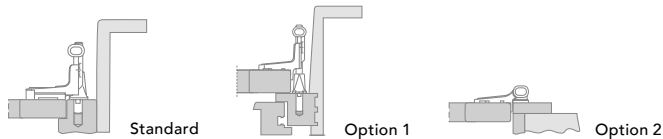

INFORMATIONS TECHNIQUES
TECHNICAL INFORMATION

TYPE DE POSE

TYPE OF INSTALLATION

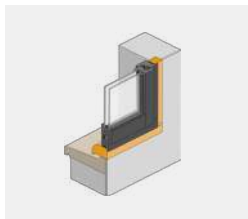

Pose en rénovation

lors de la pose en rénovation, la menuiserie est fabriquée sur mesure pour s'adapter au cadre existant. On conserve l'ancien dormant. La pièce d'appui existante peut-être remplacée par une neuve.

With renovation installation, the joinery is custom-made to fit the existing frame. The old frame is retained. The existing sill can be replaced by a new one.

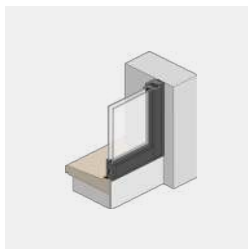

Pose en applique

lors de la pose en applique, on va poser la fenêtre contre le mur intérieur. L'épaisseur de la fenêtre est celle de l'isolant. Avec des tapées, cette pose s'adapte à tous types d'épaisseurs. On obtient ainsi un maximum de surface vitrée.

With surface-mounted installation, the window is placed against the inside wall. The thickness of the window is the same as that of the insulation. With tapées, this type of installation adapts to all types of thickness. The result is maximum glazed surface.

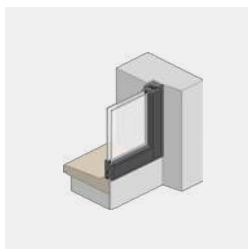

Pose en feuillure

L'ancien dormant est déposé, la fenêtre est encastrée dans un angle rentrant dans la maçonnerie, appelée feuillure. La pose permet de conserver une surface vitrée identique à celle de l'ancienne fenêtre.

The old frame is removed, and the window is fitted into a recessed angle in the masonry, called a rebate. The glazed surface remains identical to that of the old window.

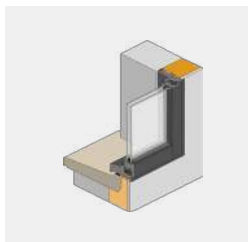

Pose en tunnel

La fenêtre est posée dans l'épaisseur du mur.

The window is installed in the thickness of the wall.

COLLECTION DE VITRAGE

GLASS COLLECTION

Le Coefficient Ug: Désigne les performances thermiques du vitrage.

Le Coefficient Sw: Désigne les performances de transmission solaire.

Le Facteur Solaire g: Exprime la transmission énergétique globale, c'est-à-dire la quantité totale d'énergie solaire que laisse passer un vitrage et sa contribution à l'échauffement de la pièce.

Le Coefficient Rw(dBa): Est l'indice d'affaiblissement acoustique, qui montre la capacité d'un vitrage à empêcher la transmission des sons provenant de l'extérieur.





Ug - Coefficient: Refers to the thermal insulation of the glass.

Sw - Coefficient: Refers to the solar transmission performance.

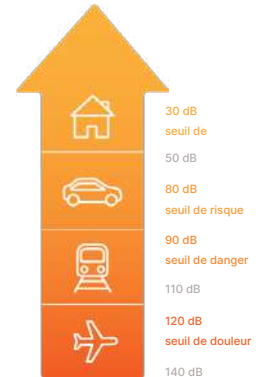
g - Solar Factor: Expresses the global transmission of energy, ie the total amount of solar energy passing through a glazed window and its contribution to the heating of the room.

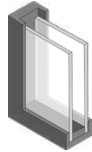
Rw coefficient (dBa): Is the sound insulation index, which shows the ability of a glazed window to block the transmission of sounds from outside.



				
	Double Vitrage Standard Standard Double Glazing 4/ 16ARG/ 4 thermo thermal	Triple Vitrage Triple Glazing 4/ 16ARG/ 4 / 16ARG/ 6	Double vitrage Phonique Soundproof Double Glazing 10/ 16ARG/ 4 thermo	Double vitrage Sécurité Security Double Glazing 44.2/ 16ARG/ 4 thermo
Ug	1.1	0.9	1.1	1.0
Sw	81%	75%	70%	70%
g	81%	58%	38%	47%
Rw (dBa)	35	32	37	37

COLLECTION DE VITRAGE

GLASS COLLECTION

Mestre Raposa International® dispose d'une large gamme de vitrages parfaitement adaptés à la création d'espaces intérieurs lumineux, confortables et sécurisés.

Mestre Raposa International® offers a wide range of glazings perfectly suited to creating bright, comfortable, and secure interior spaces.



CHINCHILLA

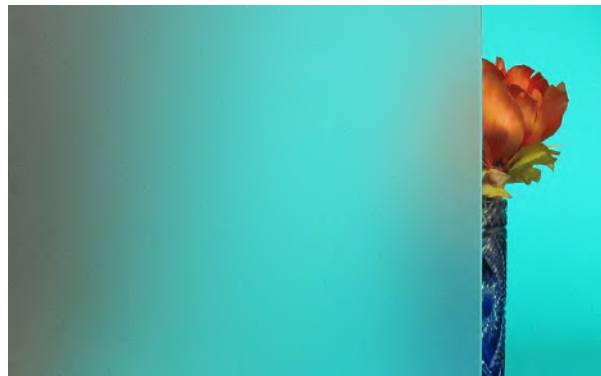

DECORMAT



MASTERCARRE



MASTERLIGNE

INTERCALAIRE SWISSPACER WARM EDGE

Le « warm edge » ou bord chaud désigne le joint périphérique d'un vitrage isolant composé d'une matière à faible conductivité thermique. Les intercalaires Swisspacer garantissent une qualité exceptionnelle pour des fenêtres robustes et à haute performance énergétique. L'aspect sobre, le large choix de couleurs et la finition mate satinée apportent une valeur esthétique supplémentaire.

The term 'warm edge' refers to the peripheral seal of an insulating glazing consisting of a material with low thermal conductivity. Swisspacer spacers ensure exceptional quality for robust and high-energy-efficient windows. The understated appearance, wide range of colors, and satin matte finish provide additional aesthetic value.



Gamme de couleurs disponibles
Range of available colors

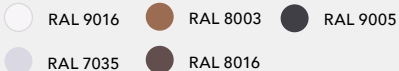

PETIT BOIS GEORGIAN BARS



Standard

Collés ou vitrage, avec ou sans intercalaire fictif.
Adhesive or glazed, with or without a georgian bar.

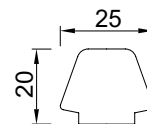

Dessin Technique
Technical Design

Traditionnel / Traditional

Collés ou vitrage, avec ou sans intercalaire fictif.
Adhesive or glazed, with or without a georgian bar.

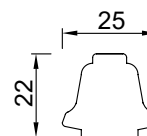

Dessin Technique
Technical Design

Incorporés au vitrage, disponible en plusieurs couleurs:
8 mm, 18 mm, 26 mm, 48 mm.
Inside glass, available in different colours:
8 mm, 18 mm, 26 mm, 48 mm.



QUINCAILLERIE MODERNE MODERN HARDWARE

Poignées de fenêtre bois et bois-aluminium / Wooden and wood-aluminum window handles

Hoppe Atlanta (standard) Ref: 031



F1 Aluminium Silver F9 Aluminium Steel F3 Laitonné
F3 Aluminium Gold RAL 8017 Marron
RAL 8707 Dark Brown RAL 9016 Blanc
RAL 9016 Traffic White

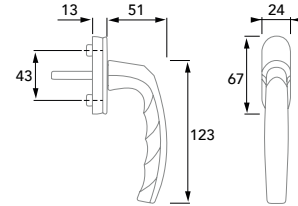

Dessin Technique
Technical Design

Hoppe Toulon Ref: 032



F1 Aluminium Silver F9 Aluminium Steel F3 Laitonné
F3 Aluminium Gold RAL 8017 Marron
RAL 8707 Dark Brown RAL 9016 Blanc
RAL 9016 Traffic White

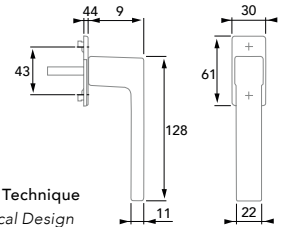

Dessin Technique
Technical Design

Poignées de porte d'entrée / Entrance door handles

35A/1040 G6/S Ref: 034

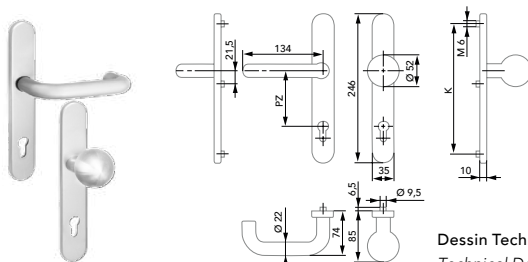

Dessin Technique
Technical Design

35A/1200 Ref: 038

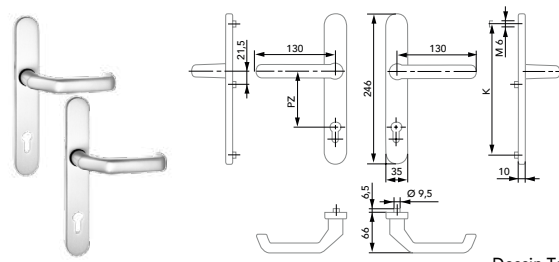

Dessin Technique
Technical Design

QUINCAILLERIE TRADITIONNELLE TRADITIONAL HARDWARE

Crémone pour profil Mouton et Gueule de Loup
Crémone for Mouton et Gueule de Loup profile

Crémone en applique Arinov avec boîtier de 42 mm :
Arinov crémone with 42 mm casing:

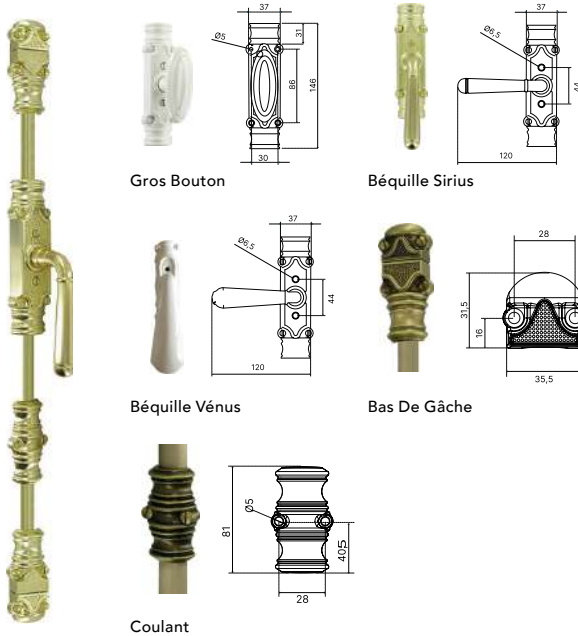

Barre de tirage bois et bois-aluminium
Vertical handles for wood and wood-aluminium window

Hoppe M476/15 Ref: 047

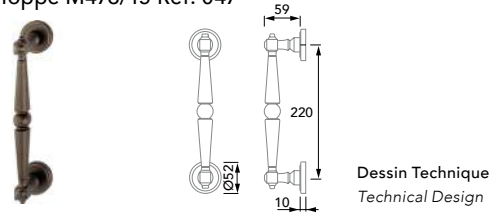

Hoppe 509 Ref: 048

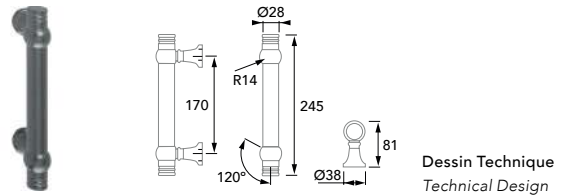

Fausse crémone bois / French style handles for wood windows

Fausse Crémone Arinov Ref: 046 / Arinov False Crémone Ref: 046

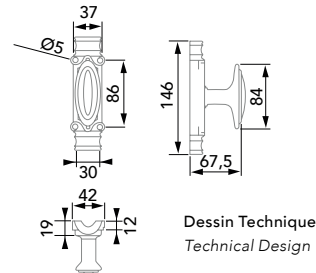

Poignées de fenêtre bois et bois-aluminium / Wood and wood-aluminium window handles

Hoppe Singapore Ref: 043



Laiton
Brass



Argent
Silver



Laiton Patiné
Anquite Brass

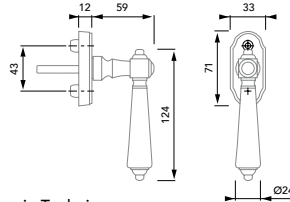

Dessin Technique
Technical Design

Poignées de porte fenêtre bois et bois-aluminium / Wood and wood-aluminium balcony door handles

Hoppe Singapore Ref: 044



Laiton
Brass



Argent
Silver



Laiton Patiné
Anquite Brass

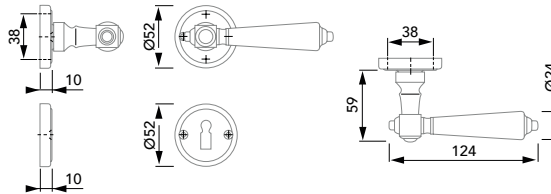

Dessin Technique
Technical Design

Hoppe Elba Ref: 045



Laiton
Brass



Laiton Patiné
Anquite Brass

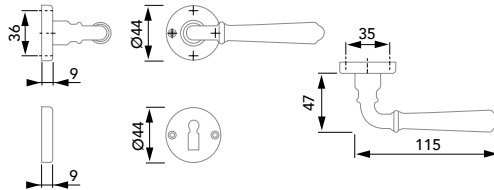

Dessin Technique
Technical Design

TEINTES DE VERNIS BOIS

WOOD VARNISHES



1/22

2/22

3/22

4/22

5/22

6/22

Pin Pine



Méranti Meranti

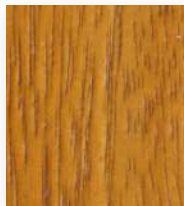

Chêne Oak



Mélèze Larch

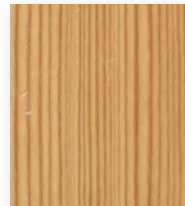

TEINTES DE VERNIS BOIS

WOOD VARNISHES



7/22

8/22

9/22

10/22

11/22

12/22

Pin Pine						
Méramti Meranti						
Chêne Oak						
Mélèze Larch						

GAMME DE COULEURS NCS

NCS COLORS RANGE



Mestre Raposa International® propose également l'ensemble des couleurs du système « Natural Color System » (NCS). Cette référence retient comme base 6 teintes élémentaires considérées comme pures. S'ajoutera à cela 3 paramètres qui composent chaque élément à savoir : la teinte, la quantité de noir et la chromie. Retrouvez l'ensemble des couleurs NCS (2050 teintes) sur le lien suivant : <https://couleurncs.fr/>

Mestre Raposa International® also offers all the colors of the "Natural Color System" (NCS). This reference selects 6 elemental shades considered pure as its base. Additionally, there are 3 parameters that compose each element: hue, amount of black, and chroma. Find all NCS colors (2050 shades) at the following link: <https://couleurncs.fr/>

GRILLES D'AERATION VENTILATION GRILLES

Regel-Air H - Type 24

Une solution particulièrement adaptée pour une meilleure circulation de l'air.
A particularly suitable solution for improved air circulation.

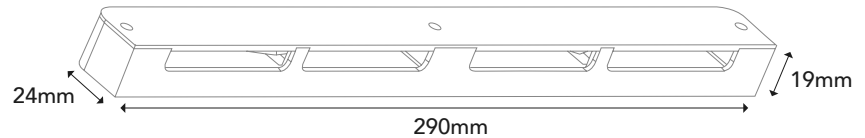
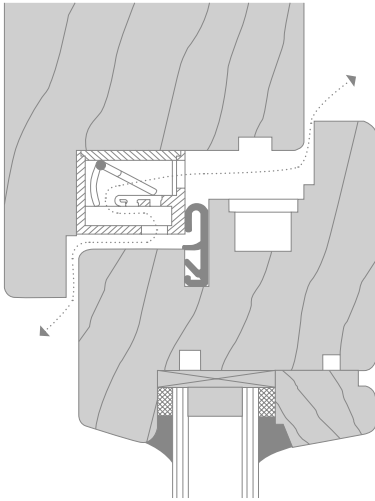

Dessin Technique
Technical Design

Sur les côtés extérieurs et intérieurs de la fenêtre, on ne voit pas les grilles de ventilation.

Ainsi, l'architecture intérieure et extérieure ne s'altère pas comme c'est le cas avec les systèmes de ventilation traditionnels

On the exterior and interior sides of the window, ventilation grilles are not visible. Thus, both interior and exterior architecture remains unaltered, unlike traditional ventilation systems.

CERTIFICATIONS

CERTIFICATIONS



Institut Technologique en charge des Filières Forêt-Bois et Ameublement.
Technological Institute for Forest Cellulose Wood Construction Furniture.



ITCONS Université de Coimbra, Institut de Recherche et Développement Technologique, Portugal.
ITCONS, University of Coimbra, Institute of Technological Research and Development, Portugal.



Composants de Maison Passive, Institut de la Maison Passive (PHI), Allemagne.
Passive House Components, The Passive House Institute (PHI), Germany.



CEKAL Certification des Vitrages en France.
CEKAL Glass Certification, France.



Certificat FSC, Conseil de Gestion Forestière® - FSC®.
FSC Certificate, Forest Stewardship Council® - FSC®.



GUIDE D'ENTRETIEN DES MENUISERIES

WINDOW AND DOOR MAINTENANCE GUIDE

Conseils et recommandations

le nettoyage régulier du châssis et du cadre des fenêtres en bois, de l'extérieur aussi bien que de l'intérieur est important : il est nécessaire d'utiliser des agents de nettoyage doux dont le ph est compris entre 5 et 8. les meilleurs produits à utiliser sont les nettoyeurs ménagers respectueux de l'environnement, les nettoyeurs neutres tout usage ou les savons neutres. il ne faut en aucun cas appliquer des substances agressives telles que des nettoyeurs à base de solvants, des agents abrasifs ou des nettoyeurs alcalins universels.

Entretien des vitrages

le vitrage doit être nettoyé avec un chiffon doux non abrasif additionné d'un nettoyeur pour vitre.

Entretien des quincailleries

lubrifier toutes les pièces mobiles ainsi que les points de fermeture. vérifier le bon fonctionnement .
pour les menuiseries à fermeture mouton et gueule de loup, graisser tout le long de la fermeture avec un lubrifiant au minimum deux fois par an. plus d'informations sont disponibles dans notre newsletter : <https://mestreraposa.fr/actualites/entretien-des-fenetres-en-bois/>.

Tips and recommendations

Regular cleaning of the wooden window sash and frame, both on the exterior and interior, is important: it is necessary to use gentle cleaning agents with a pH between 5 and 8. The best products to use are environmentally friendly household cleaners, neutral all-purpose cleaners, or mild soaps. Under no circumstances should aggressive substances such as solvent-based cleaners, abrasive agents, or universal alkaline cleaners be applied.

Glass maintenance

The glass should be cleaned with a soft, non-abrasive cloth dampened with glass cleaner.

Hardware maintenance

Lubricate all moving parts as well as locking points. Check for proper operation.
For windows with a sheep and wolf closure, grease along the closure at least twice a year with a lubricant. More information is available in our newsletter: <https://mestreraposa.fr/actualites/entretien-des-fenetres-en-bois/>.



KIT D'ENTRETIEN MAINTENANCE KIT

Un kit d'entretien complet pour fenêtres et portes en bois du fabricant Adler peut également être commandé chez Mestre Raposa International® au prix de 29,50 €, plus frais de port.

Ce dernier contient les éléments suivants:

- Adler Top-Cleaner 250 ml.
- Adler Top Care 250 ml.
- 2 Têtes de pulvérisation.
- 1 Lingette de nettoyage (Top-Cleaner).
- 1 Lingette d'entretien (Top-Care).

Plus d'informations sont également disponibles sur : <https://www.adler-verniss.fr>

A complete maintenance kit for wooden windows and doors from the manufacturer Adler can also be ordered from Mestre Raposa International® for the price of €29.50, plus shipping costs.

This kit includes the following elements:

- Adler Top-Cleaner 250 ml.
- Adler Top Care 250 ml.
- 2 Spray heads.
- 1 Cleaning wipe (Top-Cleaner).
- 1 Maintenance wipe (Top-Care).

Additional information is also available at: <https://www.adler-verniss.fr>



GARANTIE DE MESTRE RAPOSA

WARRANTIES MESTRE RAPOSA



Tableau des garanties / Warranty table

Profil en bois et bois-aluminium / Wooden profile and wood-aluminum	10 ans / years
Vitrage / Glass	5 ans / years
Volets Battants / Shutters	5 ans / years
Quincailleries / Hardware	2 ans / years

*Consultez la version complète de la garantie sur nos conditions générales de vente.

*Please refer to the full warranty in our terms and conditions of sale.

Après paiement complet, les biens vendus par Mestre Raposa International ® sont garantis par cette dernière. Le vice de la fabrication doit apparaître dans une période de trois mois à compter de la date de livraison et pour une utilisation du bien défini dans la commande.

Cette garantie est de 10 ans pour les profils de fenêtres en Bois et en Bois aluminium, de 5 ans pour les volets battants en Bois, et de 2 ans pour le vitrage et la quincaillerie.

Pour être recevable, toute réclamation doit être formulée par lettre recommandée avec AR et dans la période de trois mois.

Garantie du verre : 5 ans contre la condensation à l'intérieur de la chambre du double vitrage. Le brisement du verre dû à un choc thermique, au vol, à l'usage de la force ou à un cas de force majeure n'est pas couvert par la garantie.

Garantie de 2 ans pour les moteurs et les commandes électriques. Au titre de la garantie, Mestre Raposa, remplacera gratuitement les pièces reconnues défectueuses.

La garantie est exclue dans les cas suivants :

- Un stockage défectueux à l'origine du mauvais fonctionnement des menuiseries.
- Si le fonctionnement provient d'une négligence ou défaut d'entretien de la part de l'acheteur.
- Si des coups ou rayures surviennent pendant la durée du chantier, lors de l'installation des menuiseries.
- Toute modification de la menuiserie, non autorisée par Mestre Raposa, entraîne l'annulation de la garantie.

After full payment, goods sold by Mestre Raposa International® are guaranteed by the company. Manufacturing defects must appear within a period of three months from the delivery date and for a specific use defined in the order.

This warranty is for 10 years for wooden and wood-aluminum window profiles, 5 years for wooden shutters, and 2 years for glazing and hardware. To be eligible, any claim must be made by registered letter with acknowledgment of receipt within the three-month period.

Glass warranty: 5 years against condensation inside the double glazing unit. Glass breakage due to thermal shock, theft, the use of force, or force majeure is not covered by the warranty.

2-year warranty for motors and electrical controls. Under the warranty, Mestre Raposa will replace defective parts free of charge.

The warranty is excluded in the following cases:

- Defective storage causing malfunction of the joinery.
- If the malfunction results from negligence or lack of maintenance by the buyer.
- If bumps or scratches occur during the construction period, during the installation of the joinery.
- Any modification of the joinery, not authorized by Mestre Raposa, will result in the cancellation of the warranty.

Adresse pour courrier postal:
140 Bis, Rue de Rennes
75006 Paris

T: +33 1 77 45 52 37
E: info@mestreraposa.fr

www.mestreraposa.fr
facebook.com/mestreraposafrance
[@mestre.raposa.fr](https://mestre.raposa.fr)